











HLC Light duty metal anchors

Economical sleeve anchor

Anchor version			Benefits
	HLC (M5-M16)	Hex head nut with pressed-on washer	- Various head shapes and fastenings thickness
	HLC-H (M5-M16)	Bolt version with washer	
	HLC-L (M5-M16)	Torx round head	
	HLC-SK (M5-M16)	Torx counter sunk head	
	HLC-EC (M5-M16)	Loop-hanger head, eyebold closed	
	HLC-EO (M5-M16)	Loop-hanger head, eyebold open	
	HLC-T (M5-M16)	Ceiling hanger	

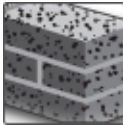
Base material	Load condition
 Concrete (non-cracked)  Solid brick	 Fire resistance

Approvals/certificates

Description	Authority/Laboratory	No./date of issue
Fire test report	IBMB, Braunschweig	PB 3093/517/07-CM / 2007-09-10
Assessment report (fire)	Warringtonfire	WF 327804/A / 2013-07-10



Basic loading data (for a single anchor)

All data in this section is Hilti technical data and applies to:

- Correct setting (See setting instruction)
- No edge distance and spacing influence
- Concrete as specified in the table
- *Steel* failure
- Minimum base material thickness
- Concrete C 20/25, $f_{ck,cube} = 25 \text{ N/mm}^2$

Effective anchorage depth

Anchor size		M5	M6	M8	M10	M12	M16
Effective anchorage depth	h_{ef} [mm]	16	26	31	33	41	41

Characteristic resistance

Anchor size		M5	M6	M8	M10	M12	M16
Tension N_{Rk}	[kN]	2,1	3,5	4,5	7,2	10,0	13,2
Shear V_{Rk}	[kN]	3,2	7,0	8,8	14,4	20,0	20,0

Design resistance

Anchor size		M5	M6	M8	M10	M12	M16
Tension N_{Rd}	[kN]	1,2	2,0	2,5	4,0	5,6	7,4
Shear V_{Rd}	[kN]	1,8	3,9	4,9	8,0	11,1	11,1

Recommended loads^{a)}

Anchor size		M5	M6	M8	M10	M12	M16
Tension N_{Rec}	[kN]	0,8	1,4	1,8	2,9	4,0	5,3
Shear V_{Rec}	[kN]	1,3	2,8	3,5	5,7	7,9	7,9

a) With overall partial safety factor for action $\gamma = 1,4$. The partial safety factors for action depend on the type of loading and shall be taken from national regulations.

Materials

Material quality

Part	Material
Anchor	HLC HLC-EC HLC-EO HLC-H HLC-L HLC-SK HLC-T
	Carbon steel tensile strength 500 MPa galvanized to min. 5 μm
	Steel Bolt Strength 8.8, galvanized to min 5 μm

Anchor dimensions

Anchor version	Thread size	h_{ef} [mm]	d [mm]	l [mm]	l_c [mm]	t_{fix} [mm]
HLC, HLC-H, HLC-EC/EO carbon steel anchors	6,5 x 25/5	16	M5	30	25	5
	6,5 x 40/20			45	40	20
	6,5 x 60/40			65	60	40
	8 x 40/10	26	M6	46	40	10
	8 x 55/25			61	55	20
	8 x 70/40			76	70	40
	8 x 85/55			91	85	55
	10 x 40/5	31	M8	48	40	5
	10 x 50/15			58	50	15
	10 x 60/25			68	60	25
	10 x 80/45			88	80	45
	10 x 100/65			108	100	65
	12 x 55/15	33	M10	65	55	15
	12 x 75/35			85	75	35
	12 x 100/60			110	100	60
	16 x 60/10	41	M12	72	60	10
	16 x 100/50			112	100	60
	16 x 140/90			152	140	95
	20 x 80/25	41	M16	95	80	25
	20 x 115/60			130	115	60
20 x 150/95	165			150	95	
HLC-SK carbon steel anchors	6,5 x 45/20	16	M5	45	-	20
	6,5 x 65/40			65		40
	6,5 x 85/60			85		60
	8 x 60/25	26	M6	60	-	25
	8 x 75/40			75		40
	8 x 90/55			90		55
	10 x 45/5	31	M8	45	-	5
	10 x 85/45			85		45
	10 x 105/65			105		65
	10 x 130/95			130		95
12 x 55/15	33	M10	80	-	35	

HLC, HLC-H, HLC-EC/EO, HLC-L

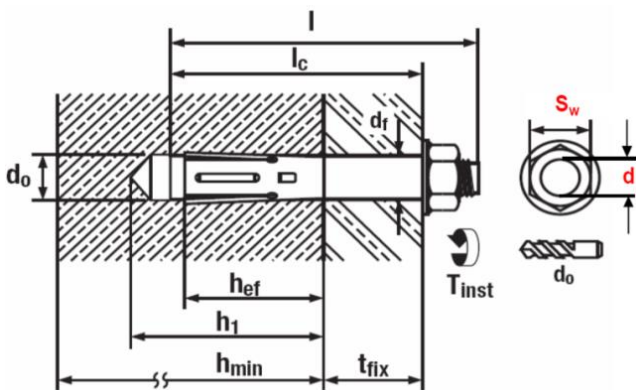

HLC-SK

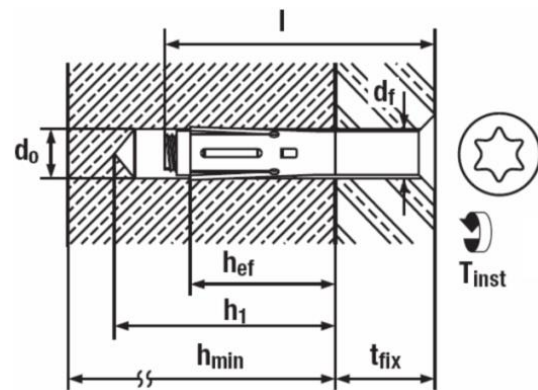



Setting information

Setting details HLC

		M5	M6	M8	M10	M12	M16
Nominal diameter of drill bit	d_0 [mm]	6,5	8	10	12	16	20
Cutting diameter of drill bit	$d_{cut} \leq$ [mm]	6,4	8,45	10,45	12,5	16,5	20,55
Depth of drill hole	$h_1 \geq$ [mm]	30	40	50	65	75	85
Width across nut flats	HLC SW [mm]	8	10	13	15	19	24
	HLC-H SW [mm]				17		
	HLS-SK Driver	PZ 3	T 30	T 40	T 40	-	-
Diameter of clearance hole in the fixture	$d_f \leq$ [mm]	7	10	12	14	18	21
Effective anchorage depth	h_{ef} [mm]	16	26	31	33	41	41
Max. torque moment concrete	T_{inst} [Nm]	5	8	25	40	50	80
Max. torque moment masonry	T_{inst} [Nm]	2,5	4	13	20	25	-

Installation equipment

Anchor size	M5	M6	M8	M10	M12
Rotary hammer for setting	TE 2 – TE 16				
Other tools	hammer, torque wrench, blow up pump				

Setting parameters

Anchor size	M6	M8	M10	M10	M12	M16	
Minimum base material thickness	h_{min} [mm]	60	70	80	100	100	120
Critical spacing for splitting failure and concrete cone failure	s_{cr} [mm]	60	100	120	130	160	160
Critical edge distance for splitting failure and concrete cone failure	c_{cr} [mm]	30	50	60	65	80	80

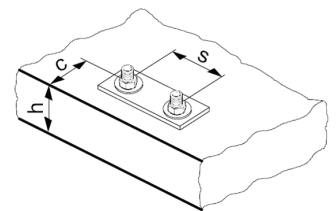

Setting instruction

*For detailed information on installation see instruction for use given with the package of the product.

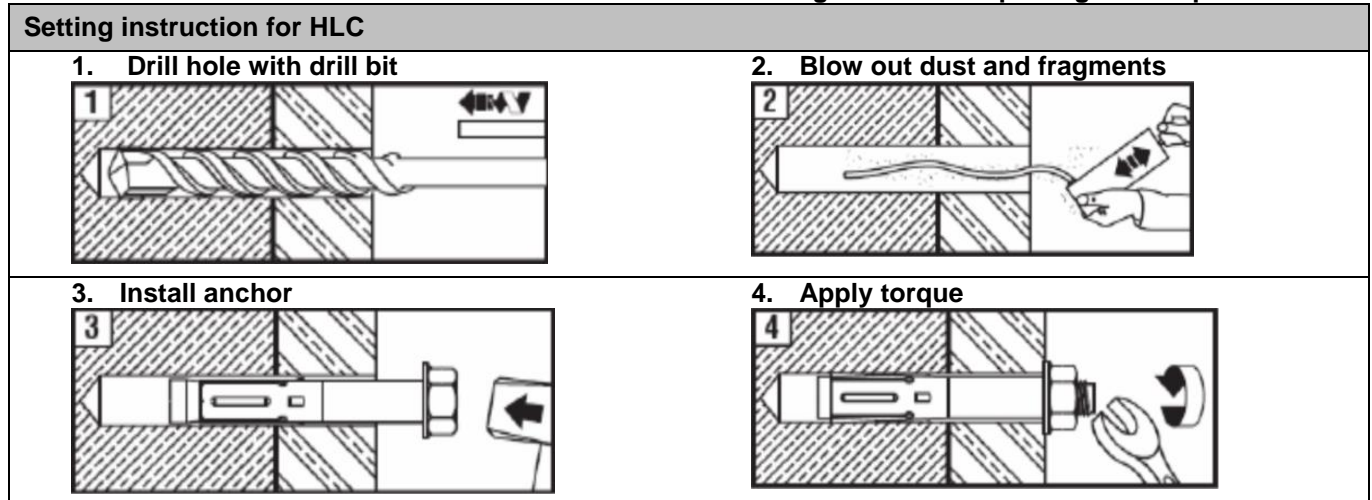

Basic loading data (for a single anchor) in solid masonry units

All data in this section applies to

- Load values valid for holes drilled with TE rotary hammers in hammering mode
- Correct anchor setting (see instruction for use, setting details)
- The core / material ratio may not exceed 15% of a bed joint area.
- The brim area around holes must be at least 70mm
- Edge distances, spacing and other influences, see below

Anchorage depth

Anchor size		M5	M6	M8	M10	M12
Nominal anchorage depth	h_{nom} [mm]	16	26	31	33	41

Recommended loads^{a)}

Anchor size		M5	M6	M8	M10	M12	
Solid clay brick Mz12/2,0 (Germany, Austria, Switzerland)							
	DIN 105/ EN 771-1 $f_b^{b)} \geq 12 \text{ N/mm}^2$	Tension $N_{Rec}^{c)}$ [kN]	0,3	0,5	0,6	0,7	0,8
		Shear $V_{Rec}^{c)}$ [kN]	0,45	1,0	1,2	1,4	1,6
Solid clay brick Mz12/2,0 (Germany, Austria, Switzerland)							
	DIN 106/ EN 771-2 $f_b^{b)} \geq 12 \text{ N/mm}^2$	Tension $N_{Rec}^{d)}$ [kN]	0,4	0,5	0,6	0,8	0,8
		Shear $V_{Rec}^{d)}$ [kN]	0,65	1,0	1,2	1,6	1,6

a) Recommended load values for German base materials are based on national regulations.

b) f_b =brick strength

c) Values only valid for Mz(DIN 105) with brick strength $\geq 19 \text{ N/mm}^2$, density $2,0 \text{ kg/dm}^3$, min. brick size NF (24,0 cm x 11,5 cm x 11,5 cm)

d) Values only valid for KS(DIN 106) with brick strength $\geq 29 \text{ N/mm}^2$, density $2,0 \text{ kg/dm}^3$, min. brick size NF (24,0 cm x 11,5 cm x 11,5 cm)



Permissible anchor location in brick and block walls

Anchor position in Brick

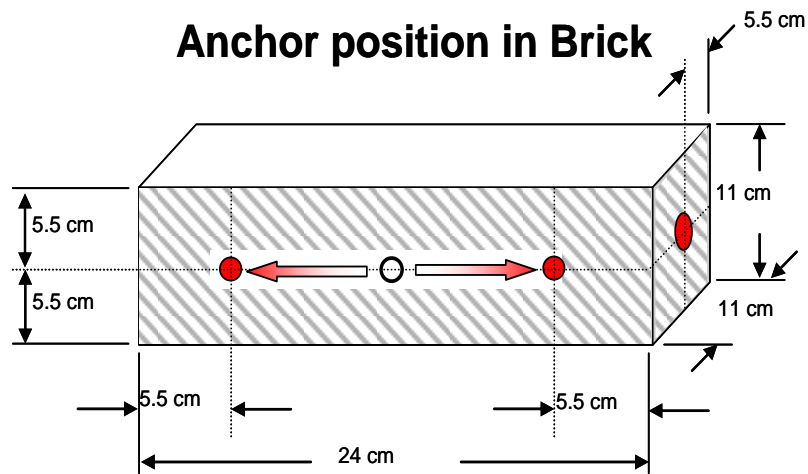

Edge distance and spacing influences

- The technical data for the HLC sleeve anchors are reference loads for MZ 12 and KS 12. Due to the large variation of natural stone solid bricks, on site anchor testing is recommended to validate technical data.
- The HLC anchor was installed and tested in center of solid bricks as shown. The HLC anchor was not tested in the mortar joint between solid bricks or in hollow bricks, however a load reduction is expected.
- For brick walls where anchor position in brick cannot be determined, 100% anchor testing is recommended.
- Distance to free edge free edge to solid masonry (Mz and KS) units ≥ 300 mm
- The minimum distance to horizontal and vertical mortar joint (c_{min}) is stated in the drawing above.
- Minimum anchor spacing (s_{min}) in one brick/block is $\geq 2 \cdot c_{min}$

Limits

- Applied load to individual bricks may not exceed 1,0 kN without compression or 1,4 kN with compression
- All data is for multiple use for non-structural applications

Plaster, graveling, lining or levelling courses are regarded as non-bearing and may not be taken into account for the calculation of embedment depth.